

5.6-7.1 GHz Linear 4W Power Amplifier 6x6mm QFN

Features

- X 16.5 dB Small Signal Gain
- X 49 dBm Third Order Intercept Point (OIP3)
- X 4W Saturated RF Power
- X Integrated Power Detector
- X 6x6mm QFN Package, RoHS Compliant
- X 100% RF Testing

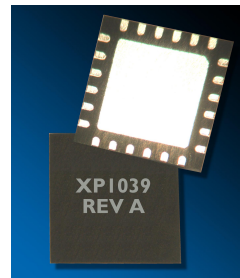

General Description

The XP1039-QJ is a packaged linear power amplifier that operates over the 5.6-7.1 GHz frequency band. The device provides 16.5 dB gain and 49 dBm Output Third Order Intercept Point (OIP3) with up to 4W of saturated RF power. The packaged amplifier comes in an industry standard, fully molded 6x6mm QFN package and is comprised of a two stage power amplifier with an integrated, temperature compensated on-chip power detector. The device includes on-chip ESD protection structures and DC by-pass capacitors to ease the implementation and volume assembly of the packaged part. The XP1039-QJ provides an alternative solution to discrete power FETS with the added advantages of higher gain and linearity in a standard QFN package. The device is well suited for Point-to-Point Radio, LMDS, SATCOM and VSAT applications.

Absolute Maximum Ratings^{1,2,3}

Supply Voltage (Vd)	+8.5V
Supply Voltage (Vgg)	-2.5V
Supply Current (Id1)	600 mA
Supply Current (Id2)	1200 mA
Detector Pin (Vdet)	6V
Detector Ref Pin (Vref)	6V
Input Power (Pin)	+25 dBm
Abs. Max. Junction/Channel Temp	175 °C
Max. Operating Junction/Channel Temp	160 °C
Continuous Power Dissipation (P _{diss}) at 85 °C	11.2 W
Thermal Resistance (T _{channel} =160 °C)	6.8 °C/W
Operating Temperature (Ta)	-40 to +85 °C
Storage Temperature (T _{stg})	-65 to +150 °C
Mounting Temperature	See solder reflow profile
ESD Min. - Machine Model (MM)	Class A
ESD Min. - Human Body Model (HBM)	Class 1A
MSL Level	MSL3

(1) Operation of this device above any one of these parameters may cause permanent damage.

(2) Channel temperature directly affects a device's MTTF. Channel temperature should be kept as low as possible to maximize lifetime.

(3) For saturated performance it recommended that the sum of $(2 \cdot V_{dd} + \text{abs}(V_{gg})) < 17$

Electrical Characteristics (Ambient Temperature T = 25 °C)

Parameter	Units	Min.	Typ.	Max.
Frequency Range (f)	GHz	5.6	-	7.1
Small Signal Gain (S21)	dB	15.5	16.5	19.0
Input Return Loss (S11)	dB		10.0	
Output Return Loss (S22)	dB		8.0	
Reverse Isolation (S12)	dB		45.0	
P1dB	dBm	34.5	35.5	
Psat	dBm		36.0	
OIP3 @ 25 dBm Pout	dBm	46	50.0	
OIP3 @ 28.5 dBm Pout	dBm	46	49.0	
PAE at Psat	%		24.0	
Detector Power Range	dBm	0.0	-	35.0
Drain Bias Voltage (Vd)	VDC		8.0	
Detector Bias Voltage (Vdet,ref)	VDC		5.0	
Gate Bias Voltage (Vg1,2,3)	VDC	-2.0	-1.0	
Quiescent Supply Current (Idq)	mA		1400	

5.6-7.1 GHz Linear 4W Power Amplifier 6x6mm QFN



October 2009 - Rev 08-Oct-09

XP1039-QJ
RoHS

Power Amplifier Measurements

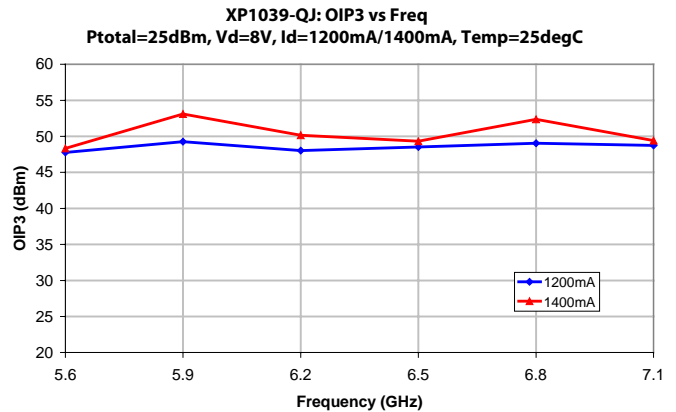
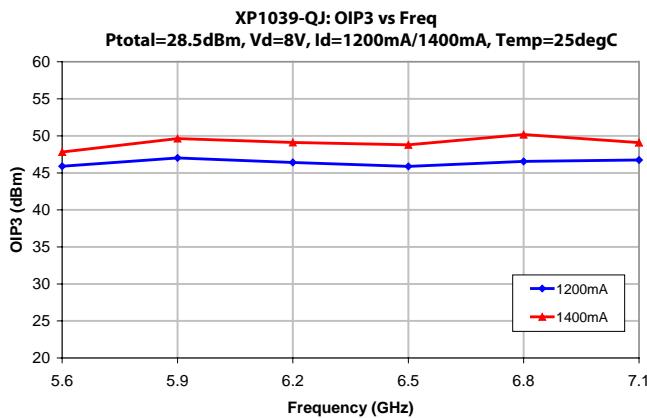
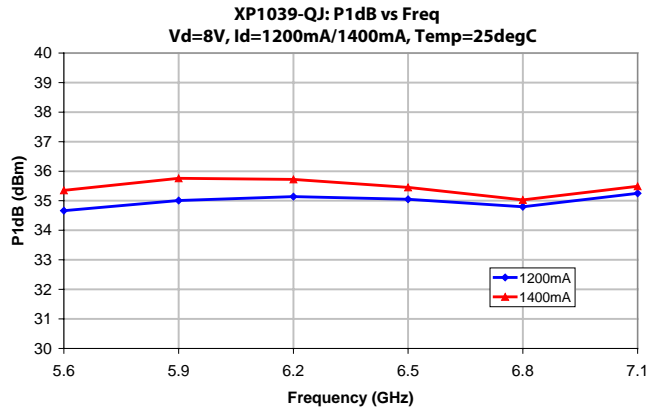
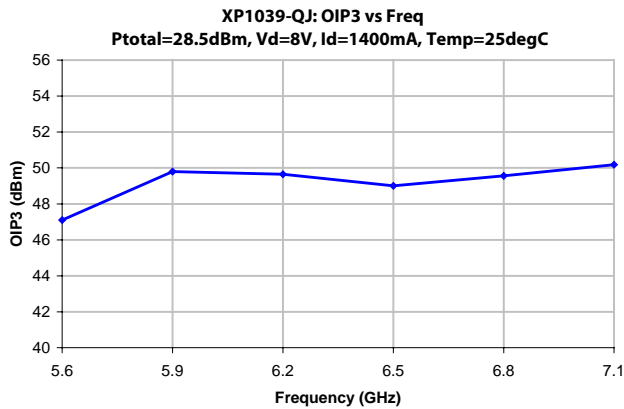
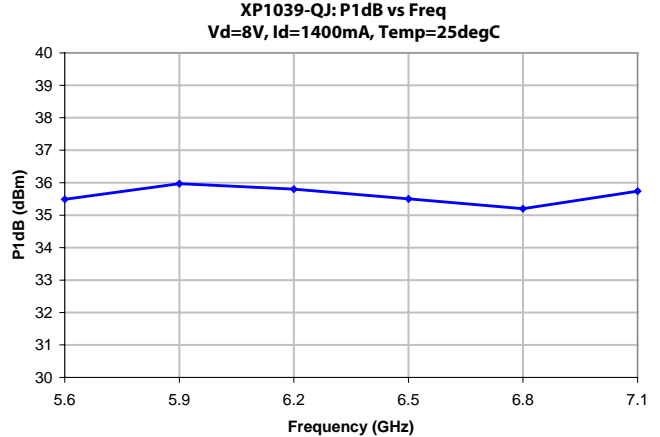
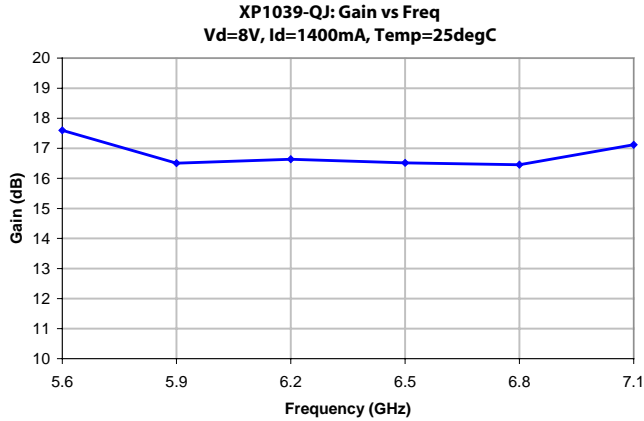

5.6-7.1 GHz Linear 4W Power Amplifier 6x6mm QFN

October 2009 - Rev 08-Oct-09

PI039-QJ
RoHS

Package Dimensions / Layout

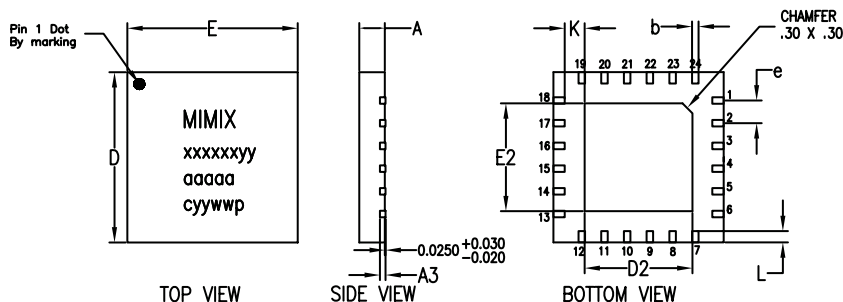

MARKINGS:

MIMIX PART/MODEL NO.

WAFER LOT NUMBER

DATE CODE = YYWW

C = COUNTRY OF ORIGIN

P = PLATING OPTION

RECOMMENDED SOLDER PAD PITCH AND DIMENSIONS
DIMENSIONS ARE IN MM

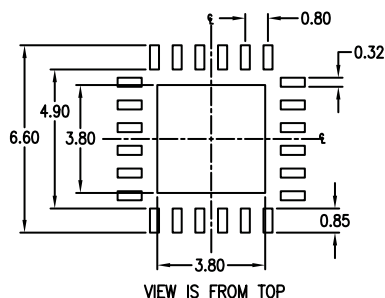

NOTES:

1. DIMENSIONS ARE IN MM.

SYM	DIMENSION IN MM		
	MIN	TYP	MAX
A	0.85	0.90	0.95
A3	0.20 REF		
b	0.18	0.23	0.28
K	0.70	-	-
D	6.00 BSC ±0.1		
E	6.00 BSC ±0.1		
e	0.80		
D2	3.70	3.80	3.90
E2	3.70	3.80	3.90
L	0.35	0.40	0.45

1. VIEWS MAY NOT BE TO SCALE; USE DIMENSIONS AND TABLE.
2. MARKINGS ARE FOR ILLUSTRATION PURPOSES ONLY. ACTUAL MARKINGS MAY VARY FOR EACH DEVICE TYPE.

Functional Schematic

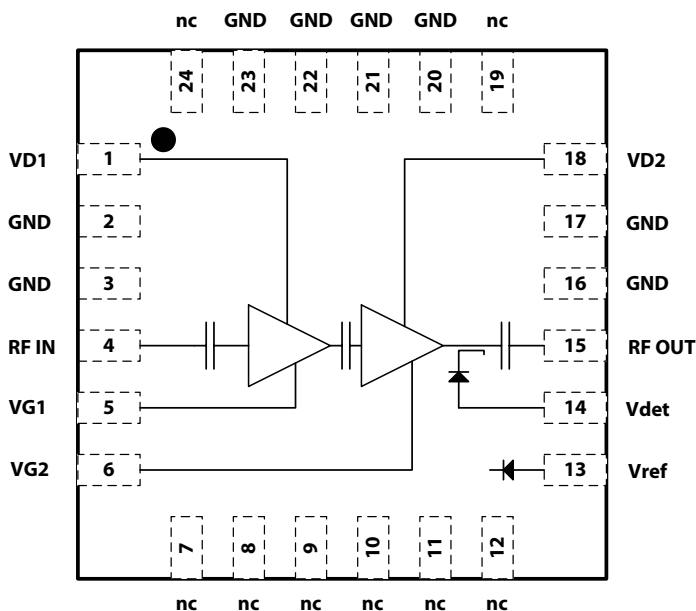

Pin Designations

Pin Number	Pin Name	Pin Function	Nominal Value
1	VD1	Drain 1 Bias	8.0V, 466mA
2-3	GND	Ground	GND
4	RF In	RF Input	
5	VG1	Gate 1 Bias	~-0.7V
6	VG2	Gate 2 Bias	~-0.7V
7-12	nc	Not Connected	GND
13	Vref	Pwr Det Reference	5.0V (100kΩ)
14	Vd2	Pwr Detector	5.0V (100kΩ)
15	RF Out	RF Output	
16-17	GND	Ground	GND
18	VD2	Drain 2 Bias	8.0V, 933 mA
19	nc	Not Connected	GND
20-23	GND	Ground	GND
24	nc	Not Connected	GND

5.6-7.1 GHz Linear 4W Power Amplifier 6x6mm QFN



October 2009 - Rev 08-Oct-09

PI039-QJ
RoHS

App Note [1] Biasing – As shown in the Pin Designations table, the device is operated by biasing Vd1,2 at 8.0V. The nominal drain currents are Id1=466mA and Id2=933mA, and this ratio of 1:2 between the first and second stage drain currents should be maintained for whatever drain current levels are used. The typical gate voltages needed are -0.7V. Make sure to sequence the applied voltage to ensure negative bias is available before applying the positive drain supply.

For linear applications it is recommended that active bias be used to keep the currents known and constant, and to maintain the best performance over temperature. Depending on the supply voltage available and the power dissipation constraints, the bias circuit may be a single transistor or a low-power operational amplifier, with a low value resistor in series with the drain supply used to sense the current.

For applications where the device is running into saturation, high power levels will be achieved by fixing the drain currents at the nominal levels with NO RF applied, and then operated with a fixed gate bias once RF is applied.

App Note [2] PWB Layout Considerations - It is recommended to provide 100pF decoupling capacitors as close as possible to the pins of the device, with additional larger decoupling capacitors further away. For example, in the Recommended Layout shown below, there are 100pF 0402 capacitors placed very near the device pins, and 1uF 0805 capacitors placed further away (the gate line shown without a 1uF capacitor (pin 6) would have this capacitor further away on the other side of the screw).

Thermal management of the device is essential. It is recommended that measures such as copper-filled vias under the package, and post/screws for top to bottom heat transfer are used (see Recommended Layout shown below). Adequate heat-sinking under the PWB is necessary in maintaining the package base at a safe operating temperature.

App Note [3] Power Detector - As shown in the schematic at right, the power detector is implemented by providing +5V bias and measuring the difference in output voltage with standard op-amp in a differential mode configuration.

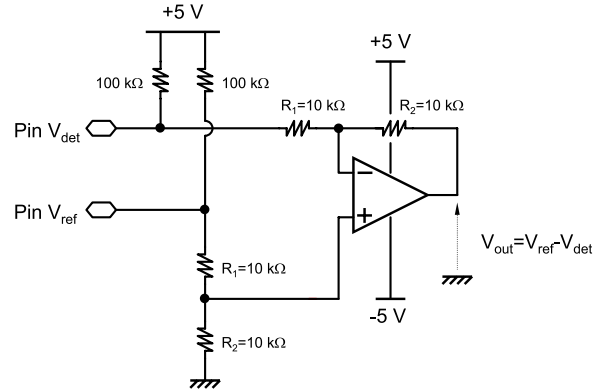

Recommended Layout

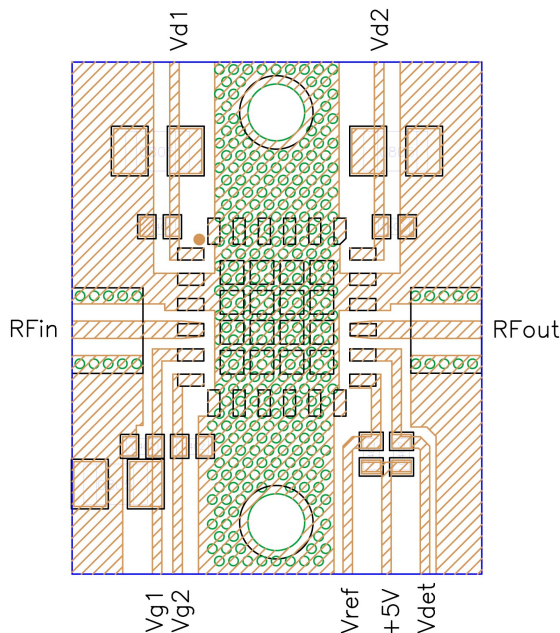

METAL 1
METAL 2
SOLDERMASK TOP – POSITIVE VIEW
VIAS

MATERIAL: R04003C, 8mil
CAPACITORS: 1uF (0805), 100pF (0402)

5.6-7.1 GHz Linear 4W Power Amplifier 6x6mm QFN

MTTF

These numbers were calculated based on accelerated life test information and thermal model analysis received from the fabricating foundry.

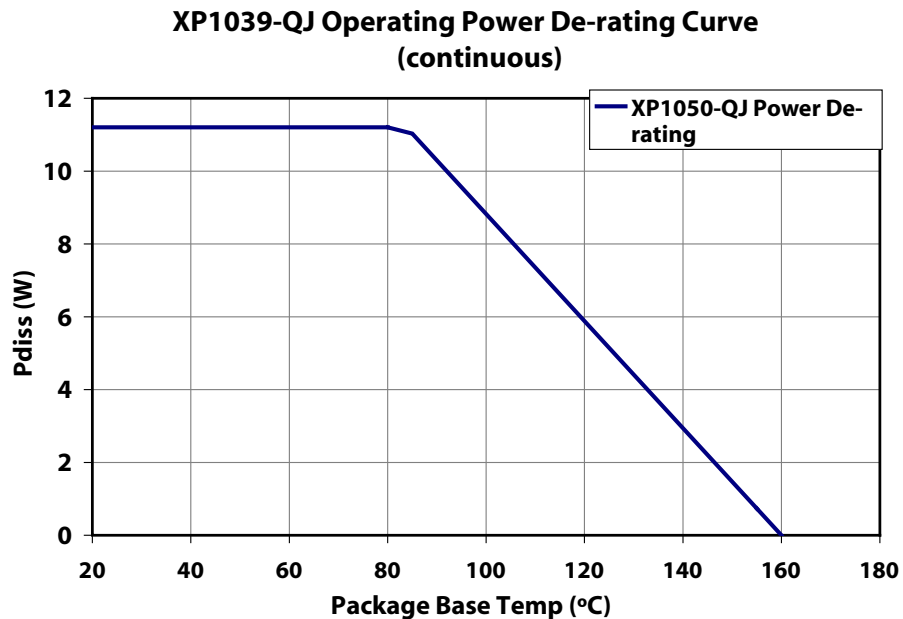
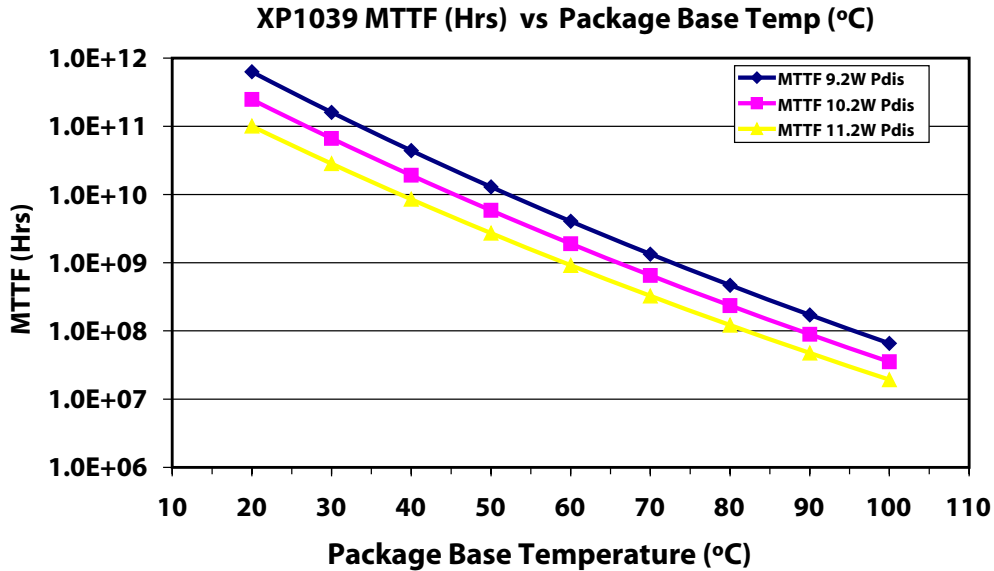

5.6-7.1 GHz Linear 4W Power Amplifier 6x6mm QFN

Handling and Assembly Information

CAUTION! - Mimix Broadband MMIC Products contain gallium arsenide (GaAs) which can be hazardous to the human body and the environment. For safety, observe the following procedures:

- Do not ingest.
- Do not alter the form of this product into a gas, powder, or liquid through burning, crushing, or chemical processing as these by-products are dangerous to the human body if inhaled, ingested, or swallowed.
- Observe government laws and company regulations when discarding this product. This product must be discarded in accordance with methods specified by applicable hazardous waste procedures.

Electrostatic Sensitive Device - Observe all necessary precautions when handling.

Life Support Policy - Mimix Broadband's products are not authorized for use as critical components in life support devices or systems without the express written approval of the President and General Counsel of Mimix Broadband. As used herein: (1) Life support devices or systems are devices or systems which, (a) are intended for surgical implant into the body, or (b) support or sustain life, and whose failure to perform when properly used in accordance with instructions for use provided in the labeling, can be reasonably expected to result in a significant injury to the user. (2) A critical component is any component of a life support device or system whose failure to perform can be reasonably expected to cause the failure of the life support device or system, or to affect its safety or effectiveness.

Package Attachment - This packaged product from Mimix Broadband is provided as a rugged surface mount package compatible with high volume solder installation. Vacuum tools or other suitable pick and place equipment may be used to pick and place this part. Care should be taken to ensure that there are no voids or gaps in the solder connection so that good RF, DC and ground connections are maintained. Voids or gaps can eventually lead not only to RF performance degradation, but reduced reliability and life of the product due to thermal stress.

Typical Reflow Profiles

Reflow Profile	SnPb	Pb Free
Ramp Up Rate	3-4 °C/sec	3-4 °C/sec
Activation Time and Temperature	60-120 sec @ 140-160 °C	60-180 sec @ 170-200 °C
Time Above Melting Point	60-150 sec	60-150 sec
Max Peak Temperature	240 °C	265 °C
Time Within 5 °C of Peak	10-20 sec	10-20 sec
Ramp Down Rate	4-6 °C/sec	4-6 °C/sec

Mimix Lead-Free RoHS Compliant Program - Mimix has an active program in place to meet customer and governmental requirements for eliminating lead (Pb) and other environmentally hazardous materials from our products. All Mimix RoHS compliant components are form, fit and functional replacements for their non-RoHS equivalents. Lead plating of our RoHS compliant parts is 100% matte tin (Sn) over copper alloy and is backwards compatible with current standard SnPb low-temperature reflow processes as well as higher temperature (260°C reflow) "Pb Free" processes.

Ordering Information

Part Number for Ordering

XP1039-QJ-0G00
XP1039-QJ-0G0T
XP1039-QJ-EV1

Description

Matte Tin plated RoHS compliant 6x6 24L QFN surface mount package in bulk quantity
Matte Tin plated RoHS compliant 6x6 24L QFN surface mount package in tape and reel
XP1039-QJ evaluation board



Caution: ESD Sensitive
Appropriate precautions in handling, packaging
and testing devices must be observed.

Proper ESD procedures should be followed when handling this device.